

## STATISTICAL ANALYSIS OF SWITCHING OVERVOLTAGES AND INSULATION COORDINATION FOR A 500 kV TRANSMISSION LINE

A.H. Hamza <sup>1</sup>, Samy M. Ghania <sup>2</sup>, Ahmed M.Emam <sup>3</sup> and Ahmed S. Shafy <sup>4\*</sup>  
<sup>1,2,4</sup> Benha University, Cairo, Egypt  
<sup>3</sup> Cairo University, Giza, Egypt  
Email: [Ahmed.Ahmed03@Feng.bu.edu.eg](mailto:Ahmed.Ahmed03@Feng.bu.edu.eg)

**Abstract:** The rapid increase in transmission voltages to fulfil higher demand of the transmitted powers yields to put the switching surges as the governing factor in the insulation design process for EHV and UHV systems. The modern methods of insulation coordination make use of probabilistic concepts and statistical procedures especially for very high voltage systems. In this paper, a sophisticated and accurate approach to calculate the switching surge flashover rate (SSFOR) using Adaptive Neuro Fuzzy Interface System (ANFIS) is developed. The variation of switching overvoltages distribution along the transmission line under different system conditions is investigated. The statistical distributions of energization overvoltages for a typical Egyptian 500kV double-line from High–Dam to Samalut are derived from the results of 100 energization cases with statistical (random) switching using alternate transient program (ATP). The statistical distributions and its key values, such as mean value, standard deviation and 2% statistical overvoltages values have been recorded. The effects of various parameters on the energization overvoltages distribution such as line length, source strength and the use of shunt reactors to control the switching surge overvoltages are considered. The developed ANFIS system estimated the SSFOR for different input parameters for both the switching overvoltages and the insulation strength distributions with high accuracy.

### 1 INTRODUCTION

The insulation level of power networks at the planning stage is decided on the basis of the peak value of transient overvoltages [1]. In general, with the increase of operating voltage, switching overvoltages rather than lightning surges determine the insulation level of the network. Consequently, the insulation level of extremely high voltages (EHV) and ultra-high voltages (UHV) systems is largely determined by the switching overvoltages (i.e., the probability of switching surge flashover rate (SSFOR)) [2, 3].

The main switching surges on the transmission line are generated by the initial closing of a circuit breaker to energize a transmission line, by the opening of a circuit breaker and by the re-closing of a circuit breaker to re-energize a transmission line. Surges can also be a result of the initiation of a fault on a transmission line. Recently, attention has been focused on the overvoltages occurring upon the energization of long lines since these are considered to be the most dangerous[4].

The insulation coordination of UHV systems, especially the clearance of external insulation for transmission lines is mainly based upon the insulation strength characteristics of typical air gaps. It is impossible to make a complete protection of the transmission line against all types of overvoltages. Therefore, the cost-effective UHV transmission line design should rely on a

probabilistic procedure which considers the statistical characteristics of overvoltages [5].

This paper presents a developed method to estimate the switching surge flashover rate (SSFOR) using Adaptive Neuro Fuzzy Interface System (ANFIS). In order to perform that, the statistical distributions of energization overvoltages for a typical Egyptian 500kV double-line from High–Dam to Samalut are derived from the results of 100 energization cases with statistical (random) switching using alternate transient program (ATP). The statistical distributions and its key values, such as mean value, standard deviation and 2% statistical overvoltages values have been recorded.

### 2 SYSTEM UNDER STUDY

The developed ATP model of a typical Egyptian 500kV double-line from High–Dam to Samalut test system considered for simulation studies is shown in Figure 1. The rated voltage of the system is 500 kV, and the base value is the maximum phase to ground voltage 449kV. Overhead transmission lines are modelled frequency dependently, and their basic parameters are shown in Table I. Phase conductors are set to transpose ideally and there are two ground wires over each tower. The soil resistivity is 100  $\Omega$ .m. The tower configurations and dimensions are shown in Figure 2.

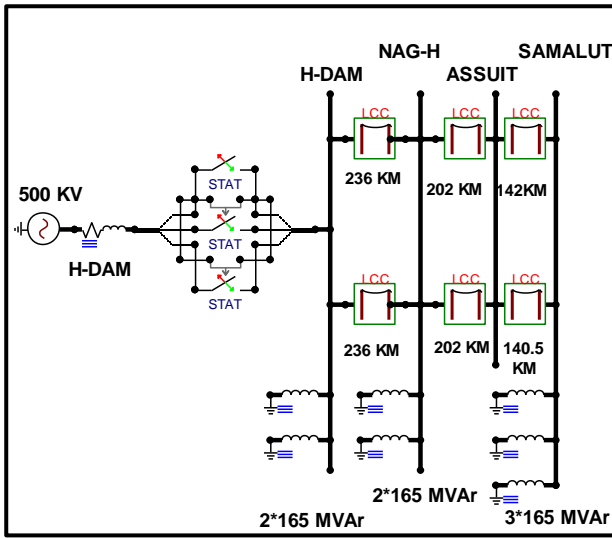

**Figure1:** The simulated model for the transmission system under study.

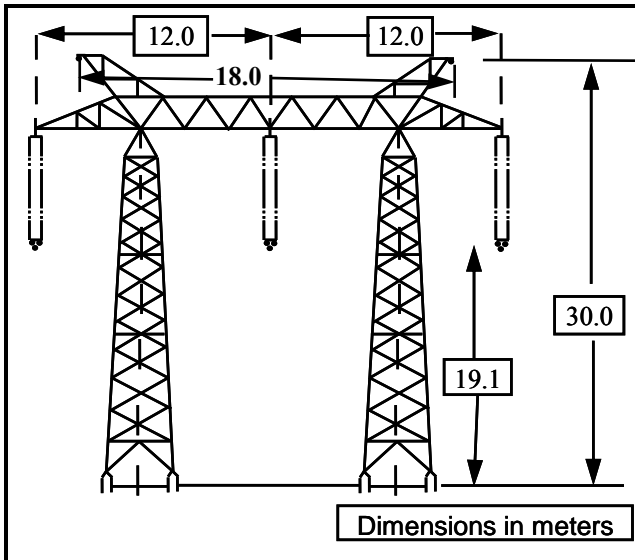

**Figure 2:** 500kv transmission line towers

**Table 1:** Data of the transmission system under study

Voltage level	500 kV
Number of circuits	2
Number of bundle conductors	3
Diameter of a single conductor	30.6 mm
Spacing between bundle conductors	47 cm
Number of sky wires	2
Diameter of sky wire	11.2 mm
Number of circuits per tower	1
Span	400 m

Table 2 shows the Lengths of different sections of the transmission line under study , with total length

of 582km. Table 3 shows the values of the shunt reactors placed at High-Dam , Nagh-Hamady and Samalut substations while there are no shunt reactors at Assuit substation as shown in the simulated model in Figure 1.

**Table 2:** Lengths of different sections of the transmission system under study

FROM	TO	Circuit no.	Length(km)
H-DAM	NAG-H	1	236
H-DAM	NAG-H	2	236
NAG-H	ASSUIT	1	202
NAG-H	ASSUIT	2	202
ASSUIT	SAMALUT	1	142
ASSUIT	SAMALUT	2	140.5

**Table 3:** Data of the shunt reactors of the transmission system under study

Bus name	Capacity (MVAR)
H-DAM	2* 165
NAG-H	2* 165
ASSUIT	No shunt reactors
SAMALUT	3* 165

### 3 RISK OF FAILURE CALCULATION

The insulation strength distribution of one 500 kV tower can be described by a cumulative Gaussian distribution  $P(V)$  having a mean denoted as the critical flashover voltage (CFO) and a standard deviation ( $\sigma$ ) of approximately equal to 5% of the CFO as shown in Figure 3 for both dry and wet conditions [6]. The distribution of the stress or the switching overvoltages (SOV) can be represented by The Gaussian probability density function  $f_s(V)$  that has the familiar bell shape as shown in Figure 3, the equation for which is [7].

$$f_s(V) = \frac{1}{\sqrt{2\pi} \sigma_o} e^{-\frac{1}{2} \left( \frac{V-\mu_o}{\sigma_o} \right)^2} \quad (1)$$

Where  $\mu_o$  : Mean value

$\sigma_o$  : Standard deviation

The switching surge flashover rate or the risk of failure under switching surge for 1 tower ,and number of n towers in parallel can be calculated using equation 2, 3 respectively [8] .

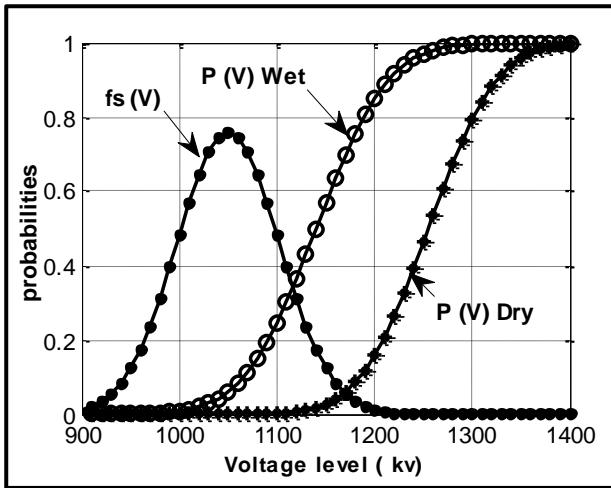

**Figure 3:** Probabilities distributions of overvoltages and flashover.

$$SSFOR_1 = \frac{1}{2} \int_{E_1}^{E_m} P(V) f_s(V) dV \quad (2)$$

$$SSFOR_n = \frac{1}{2} \int_{E_1}^{E_m} [1 - q^n] f_s(V) dV \quad (3)$$

Where:

- $E_1$ : the minimum voltage (1 pu)
- $E_m$ : the maximum SOV
- $P(V)$ : the flashover probability under a given voltage level for 1 tower
- $q$ : the probability of no flashover under a given voltage level for 1 tower which equal to  $(1 - P(V))$

The factor 1/2 means that only the flashover probability of positive polarity overvoltages is considered because the negative polarity switching surge strength is much higher than that of the positive polarity [9]. To get the effect of the switching over voltage profile which means that the overvoltage changes from one tower to another replace  $n$  in equation 3 with  $n_e$  (the equivalent number of towers in parallel) which can be calculated from equation 4 and 5 [10].

$$n_e = \frac{0.4}{1-\gamma} \frac{\sigma_f}{CFO} n \quad (4)$$

$$\gamma = \frac{E_S}{E_R} \quad (5)$$

Where  $E_S$  : mean value of the sending end voltage

$E_R$  : mean value of the receiving end voltage

#### 4 SIMULATION RESULTS

The statistical distributions and its key values, (mean values, 2% statistical over voltages, standard deviations) of overvoltages have been

derived from the results of 100 energization cases with statistical (random) switching using Case Peak Method for the different cases of study. In the statistical switching, two kinds of statistical variations were considered. The first statistical variation is the phase angle (point-of-wave) when the line circuit breakers receive the command to close. A uniform distribution from 0 to 360 degrees is assumed for this variation. The second statistical variation is the difference in closing time between the three phases. A normal distribution with standard deviation of 1 ms is assumed for this variation. Then the derived distribution is best fitted to a normal Gaussian distribution curve. The insulation strength characteristic data for one tower used for the risk of failure calculation is CFO equal to 1255, 1140 kV and standard deviation of 55, 58 kV for dry and wet conditions respectively as shown in Figure 3. The base voltage used for PU calculation is the crest line-to-neutral voltage for a maximum system voltage of 550 which equal to 449 kV.

#### 4.1 Effect of line length

As the line length increases the total line shunt capacitance increases so the peak overvoltages reaches to higher value. Figures 4-6 show the statistical distribution and the best fitted normal probability density functions of the overvoltages at receiving ends when 236 km line( from High-Dam to Nagh-Hamady), 438 km( from High-Dam to Assuit) and 582 km ( from High-Dam to Samalut) are energized with source strength of 6000MVA without shunt reactors respectively. Figures 7- 9 show the cumulative distribution functions for the previous three cases. It can be observed that as line length increases, peak overvoltages increases and hence the risk of failure also increases. Table 4 summarize the overvoltages distribution parameters (mean value, standard deviation, 2% statistical overvoltages) and the total switching surge flashover rate for dry and wet conditions for the three sections of the line.

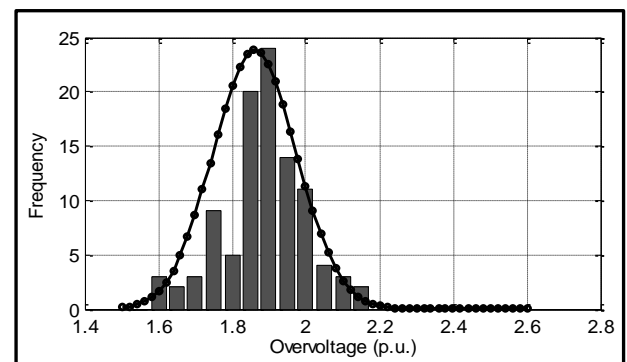

**Figure 4:** Statistical Distribution of Energization Overvoltages at Nag-H Bus, 6000 MVA, and Without Shunt Reactor.

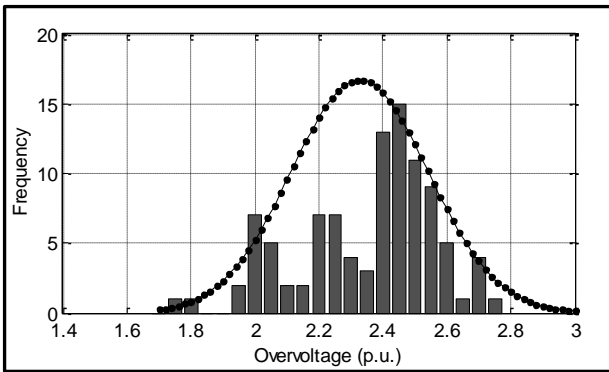

**Figure 5:** Distribution of Energization Overvoltages at Assuit Bus, 6000 MVA, and Without Shunt Reactor.

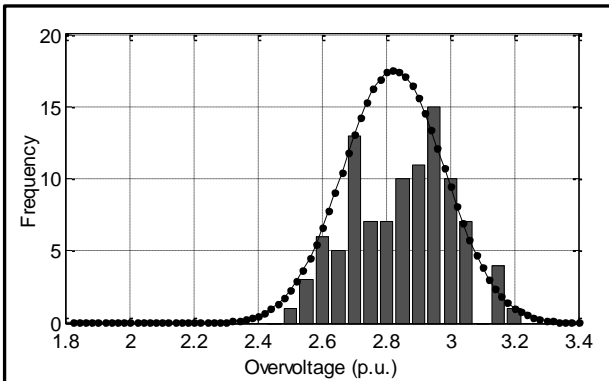

**Figure 6:** Distribution of Energization Overvoltage at Samalut Bus, 6000 MVA, and Without Shunt Reactor.

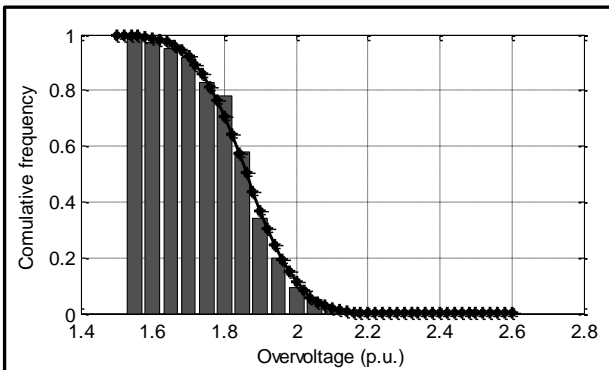

**Figure 7:** Cumulative probability Distribution of Energization Overvoltage at Nag-H Bus, 6000 MVA, and Without Shunt Reactor.

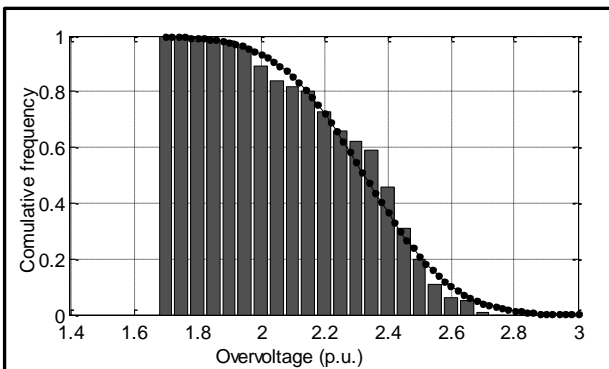

**Figure 8:** Cumulative probability Distribution of Energization Overvoltage at Assuit Bus, 6000 MVA, and Without Shunt Reactor.

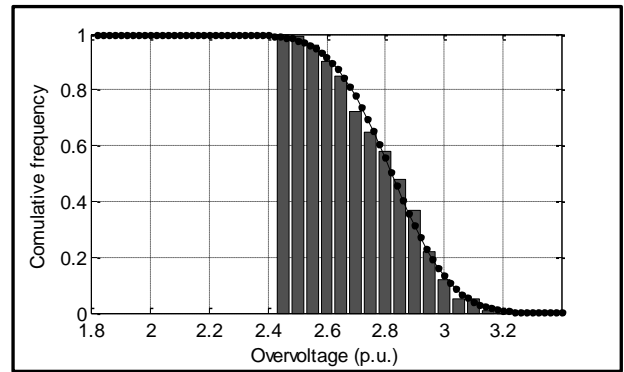

**Figure 9:** Cumulative probability Distribution of Energization Overvoltages at Samalut Bus, 6000 MVA, and Without Shunt Reactor.

**Table 4:** Effect of Transmission line length on the risk of failure

KM	$\mu$	$\sigma$	2 % SOV	SSFOR <sub>n</sub> DRY	SSFOR <sub>n</sub> WET
236	1.86	0.11	2.09	2.6E-06	5.4E-03
438	2.33	0.21	2.77	0.179	0.407
542	2.82	0.16	3.15	0.498	0.500

#### 4.2 Effect of source strength

Figures 10 and 11 show the cumulative distribution and the best fitted normal cumulative distribution functions of the overvoltage at receiving ends when 236 km line (from High-Dam to Nag-Hamady) is energized with source strength 4000 MVA, 8000 MVA respectively. It is clear that the low source strength 4000 MVA produces higher switching overvoltages and hence higher risk of failure compared to that of 6000 MVA source strength shown in Figure 7 and 8000 MVA source strength shown in Figure 11. So the switching overvoltages and the risk of failure can be alleviated by maintaining the proper source strength while energizing the transmission line. Table 5 summarizes the effect of source strength on the overvoltages distribution parameters and the calculated switching surge flashover rate.

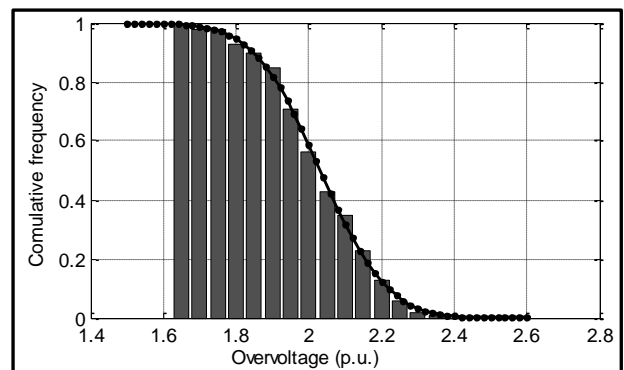

**Figure 10:** Cumulative probability Distribution of Energization Overvoltage at Nag-H Bus, 4000 MVA, and Without Shunt Reactor.

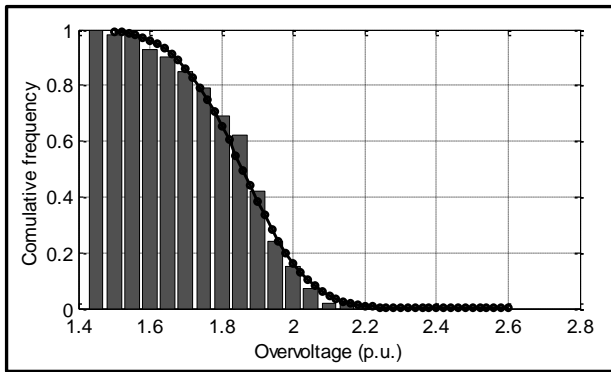

**Figure 11:** Cumulative probability Distribution of Energization Overvoltage at Nag-H Bus, 8000 MVA, and Without Shunt Reactor.

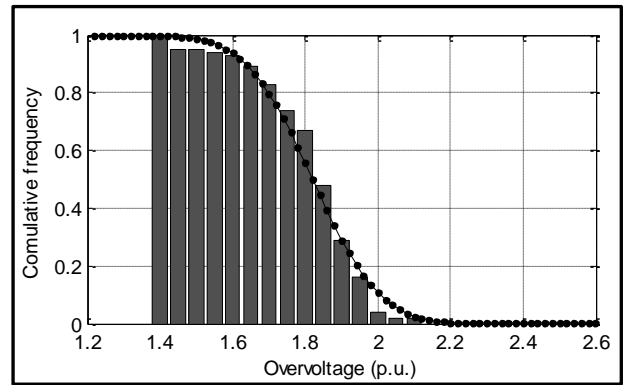

**Figure 12:** Cumulative probability Distribution of Energization Overvoltage at Samalut Bus, 6000 MVA, and With Shunt Reactor.

**Table 5:** Effect of source strength on the risk of failure

BUS	GVA	$\mu$	$\sigma$	2% SOV	SSFOR <sub>n</sub> DRY	SSFOR <sub>n</sub> WET
NAG-H	4	2.03	0.14	2.33	2.6E-03	0.110
	6	1.86	0.11	2.09	2.6E-06	5.4E-03
	8	1.85	0.13	2.12	1.7E-05	9.1E-03
ASSUIT	4	2.56	0.13	2.82	0.437	0.500
	5	2.36	0.20	2.78	0.207	0.434
	6	2.33	0.21	2.77	0.179	0.407
	8	2.23	0.17	2.58	0.078	0.350
	9	2.20	0.16	2.53	0.053	0.334
SAMALUT	4	3.23	0.15	3.54	0.500	0.500
	6	2.82	0.16	3.15	0.498	0.500
	7	2.74	0.19	3.14	0.478	0.500
	8	2.67	0.20	3.08	0.453	0.498
	9	2.57	0.23	3.04	0.383	0.486
	100	2.59	0.24	3.07	0.394	0.487
	12	2.56	0.24	3.04	0.373	0.483

### 4.3 Effect of shunt reactor

Figure 12 shows the cumulative distribution and the best fitted normal cumulative distribution function of the overvoltages at receiving end when the transmission line from High-Dam to Samalut is energized in the presence of the shunt reactors listed in Table 3. It is clear that the shunt compensation at both ends of transmission line will reduce the magnitude of switching peak overvoltages and the risk of failure. The expected shunt reactor combinations for the different energized sections are studied and summarized in Table 6. The numbers from 1-7 indicates the cases of shunt reactors combination as explained in Table 7.

**Table 6:** Effect of shunt reactor on the risk of failure

BUS	SR	$\mu$	$\sigma$	2% SOV	SSFOR <sub>n</sub> DRY	SSFOR <sub>n</sub> WET
NAG-H	1	1.75	0.10	1.96	5.4E-09	1.5E-04
	2	1.71	0.12	1.96	6.2E-08	3.2E-04
	4	1.63	0.14	1.92	4.0E-08	1.4E-04
ASSUIT	1	2.16	0.19	2.54	0.049	0.277
	2	2.11	0.20	2.52	0.037	0.234
	4	1.97	0.18	2.34	5.1E-03	0.099
SAMALUT	1	2.63	0.15	2.94	0.465	0.500
	2	2.49	0.16	2.83	0.358	0.493
	3	2.13	0.17	2.47	0.029	0.256
	4	2.33	0.16	2.65	0.167	0.448
	5	2.02	0.14	2.31	2.8E-03	0.123
	6	1.95	0.14	2.24	7.7E-04	0.063
	7	1.82	0.14	2.12	4.0E-05	0.012

**Table 7:** Explanation of the shunt reactors combination

N	SR LOCATION	N	SR LOCATION
1	HIGH-DAM	5	HIGH-DAM&SAMALUT
2	NAG-H	6	NAG-H&SAMALUT
3	SAMALUT	7	HIGH-DAM& NAG-H & SAMALUT
4	HIGH-DAM&NAG-H		

## 5 RESULTS FOR ANFIS SYSTEM

All the studied cases are collected to make training and checking data for the developed ANFIS system. ANFIS has four inputs three of them simulate the line length (the number of energized section (1-3)), the source strength (4-12) GVA and the shunt reactor combination (0-7), the fourth input simulate the insulation strength characteristics 1: for dry conditions and 0 for wet conditions. ANFIS has one output represents "the risk of insulation failure or the switching surge flashover rate" for the studied cases.

Table 8 shows a sample of the checking data, and the output of the ANFIS system. Figure 13 shows the training and checking errors for the developed ANFIS system which is less than  $3.5 \times 10^{-4}$ .

**Table 8:** A sample of the developed ANFIS system checking data and the ANFIS outputs.

SEC NO	GVA	SR	dry/wet	SSFOR <sub>n</sub>	ANFIS OUT
1	5	0	1	3.2E-05	3.1E-05
1	6	0	1	2.6E-06	2.9E-06
2	9	0	1	0.053	0.053
2	10	0	1	0.075	0.075
3	12	0	1	0.373	0.373
1	6	2	1	6.2E-08	7.1E-08
2	6	1	1	0.049	0.049
3	6	4	1	0.167	0.167
3	6	7	1	4.0E-05	4.0E-05
2	6	4	0	5.4E-03	5.4E-03
3	6	5	0	0.277	0.277
3	6	6	0	0.234	0.234
3	6	7	0	0.099	0.099

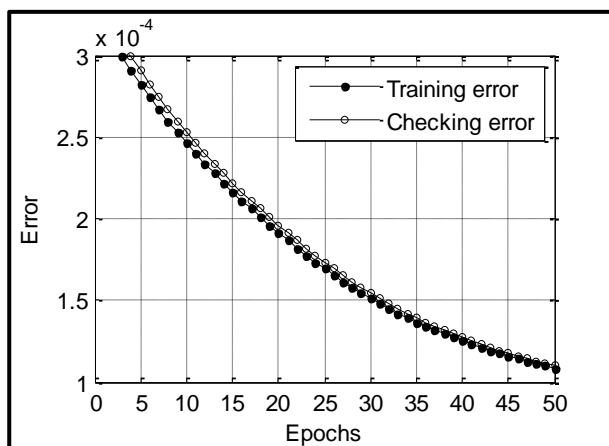

**Figure 13:** The developed ANFIS system training and checking errors

## 6 CONCLUSIONS

Simulation studies show that the switching surge overvoltages and the switching surge flashover

rate are highly increase with increasing the number of switched sections of the transmission line, so the line must be switched section by section. The risk of insulation failure can also be reduced during 500 kV line energization by using proper source strength and installing shunt reactors at both ends of the line. The switching surge flashover rates are highly increase for wet conditions and can reach to very dangerous values due to the weakness of the insulation strength under wet conditions. The developed ANFIS system estimated the SSFOR for different input parameters for both the switching overvoltages and the insulation strength distributions with high accuracy.

## REFERENCES

- [1] R. Shariatinasab, B. Vahidi, S. H. Hosseini, and A. Ametani, "Probabilistic Evaluation of Optimal Location of Surge Arresters on EHV and UHV Networks Due to Switching and Lightning Surges", IEEE Trans. on Power Delivery, Vol. 24, No. 4, pp. 1903-1911, October 2009
- [2] CIGRE WG 13-02, "Switching Overvoltages in EHV and UHV Systems with Special Reference to Closing and Re-Closing Transmission Lines", Electra, Vol.30, pp. 70-122, 1990.
- [3] A. R. Hileman, P. R. Leblanc, and G. W. Brown, "Estimating the switching surge performance of transmission lines," IEEE Trans. on PA&S, Vol. PAS-89, No. 7, pp. 1455-1469, Sep./Oct. 1970.
- [4] A. M. Mahdy, A. El-Morshedy and H. I. Anis, "Insulation Failure Assessment under Random Energization Overvoltages", IEEE Trans. on Industry Applications, Vol. 32, No.2, pp. 214-220, March/ April 1996.
- [5] Yang Li, Jinliang He, Jun Yuan, Chen Li, Jun Hu, and Rong Zeng, "Failure Risk of UHV AC Transmission Line Considering the Statistical Characteristics of Switching Overvoltage Waveshape," IEEE Trans. on Power Delivery, Vol. 28, No. 3, pp. 1731-1739, July 2013.
- [6] W. C. Guyker, A. R. Hileman, and J. F. Wittibschlager, "Full Scale Tower Insulation Test for APS 500 kV System," IEEE Trans. on PA&S, pp. 614-623, Jun. 1966.
- [7] IEC Standard 71-2, "Insulation Coordination - Part 2: Application guide," 1996.
- [8] A. R. Hileman, Insulation Coordination for Power Systems. New York: Marcel Dekker, pp. 97-99, 1999.
- [9] R. J. Lings, EPRI AC Transmission Line Reference Book-200 kV and Above, 3rd ed. Palo Alto, CA: Electric Power Research Institute, Ch. 3, 5, 2005.
- [10] G. W. Brown, "Designing EHV Lines to a Given Outage Rate-Simplified Techniques," IEEE Trans. on PA&S, pp. 379-383, Mar. /Apr. 1978.